

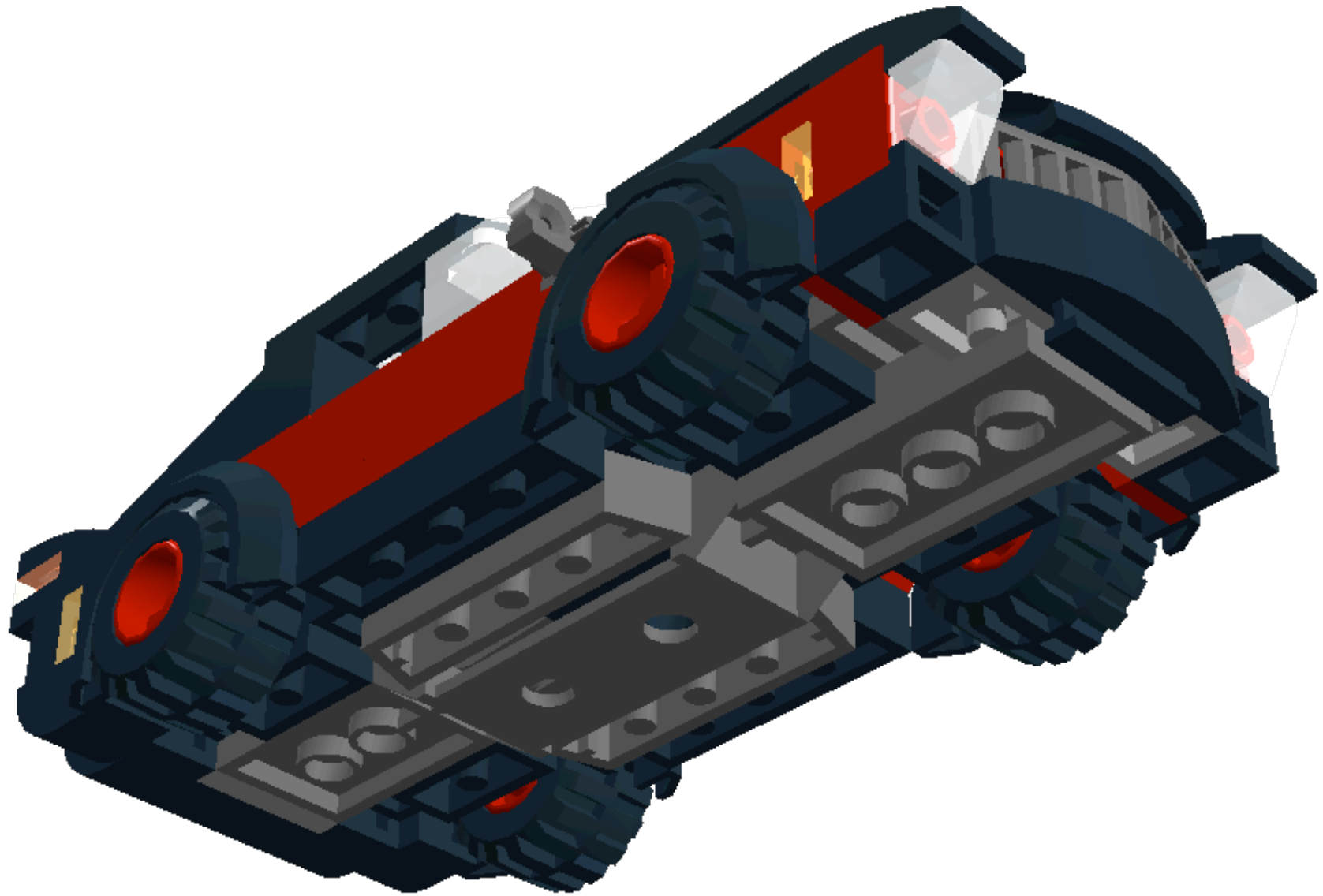

Model Name:  
**muscle\_car**

Number of Bricks: **108**



Step 1 of 45

1 x



1 x



1 x

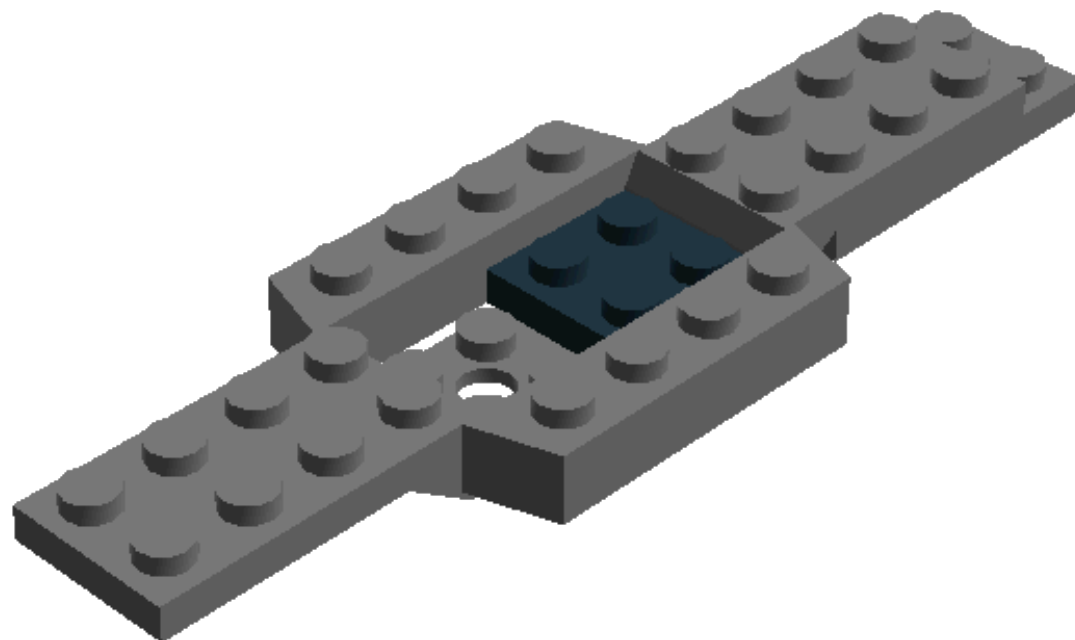

Step 2 of 45

1 x



1 x



1 x

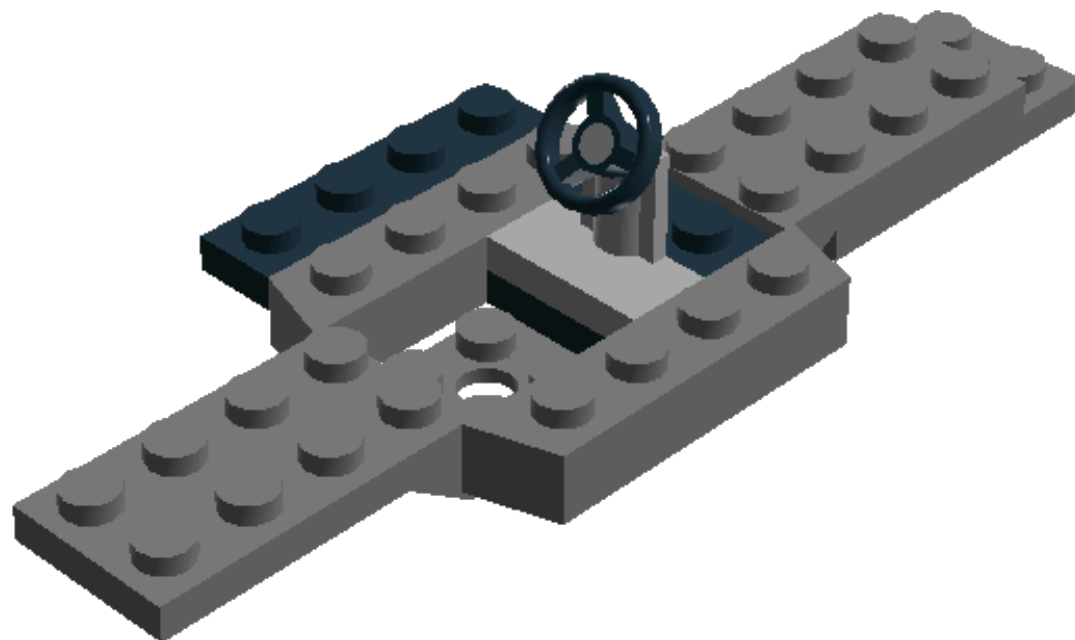

Step 3 of 45

2 x



1 x



1 x

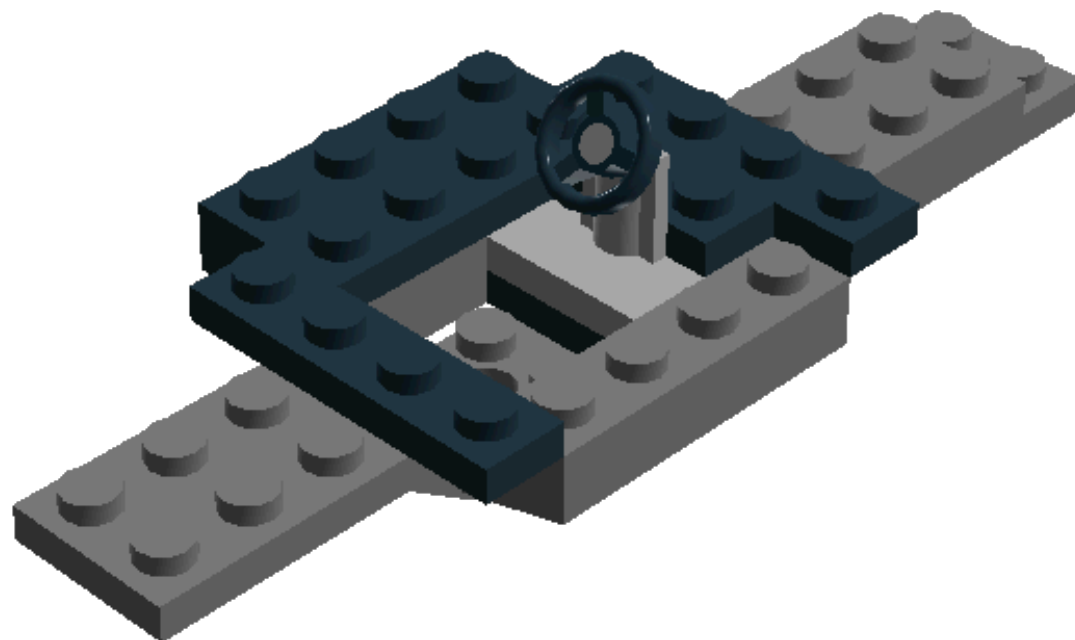

Step 4 of 45

1 x



1 x



1 x



1 x

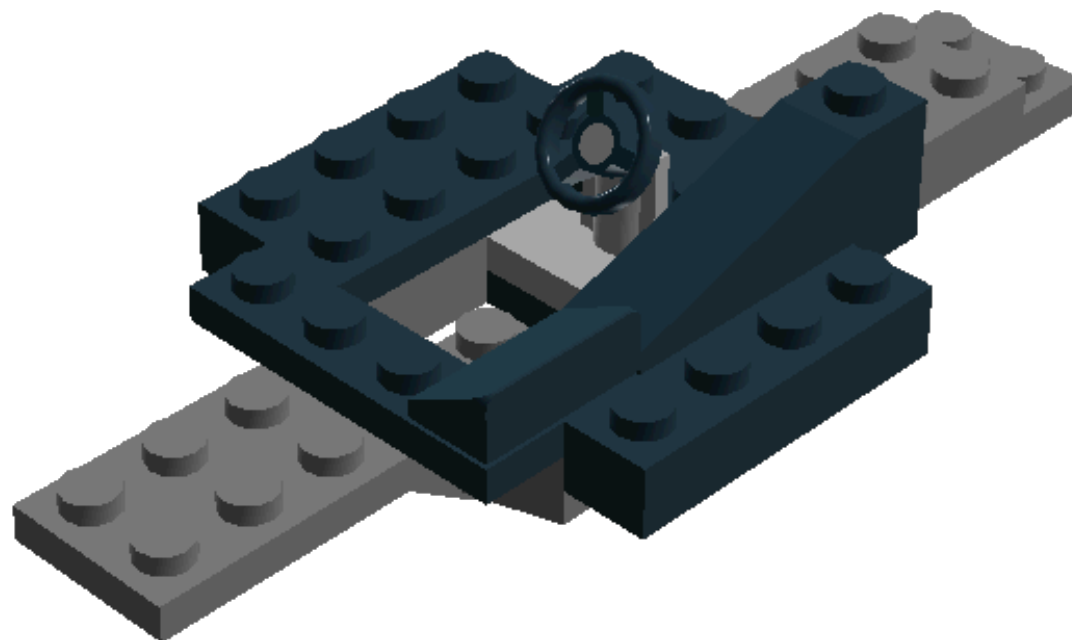

Step 5 of 45

1 x



1 x



1 x



1 x

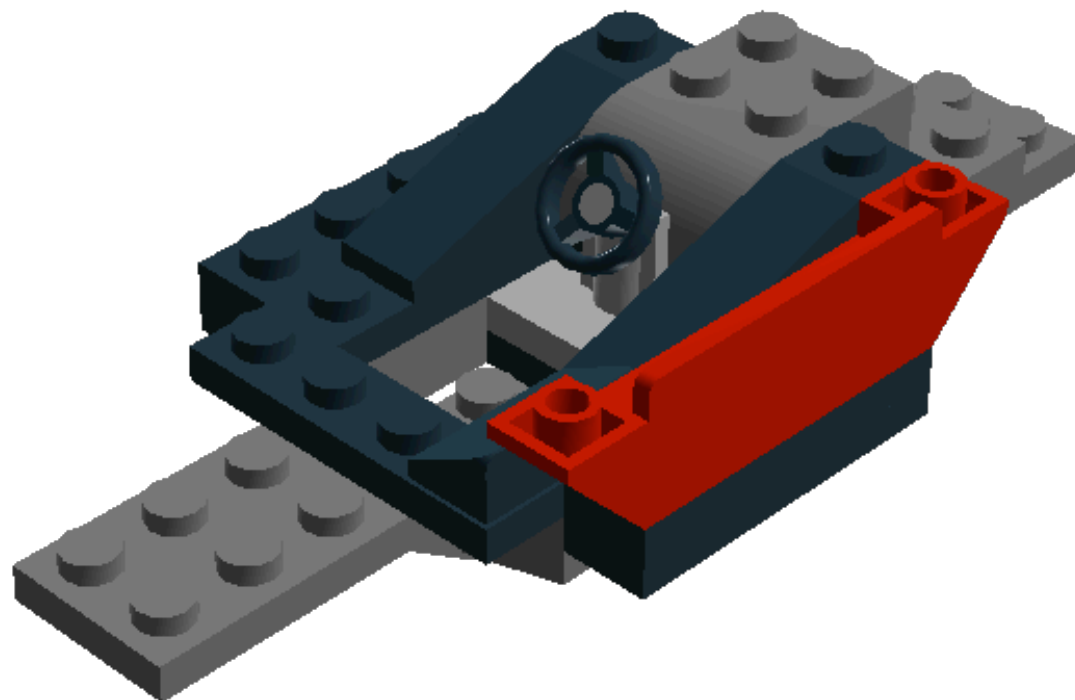

Step 6 of 45

1 x



1 x



1 x



1 x

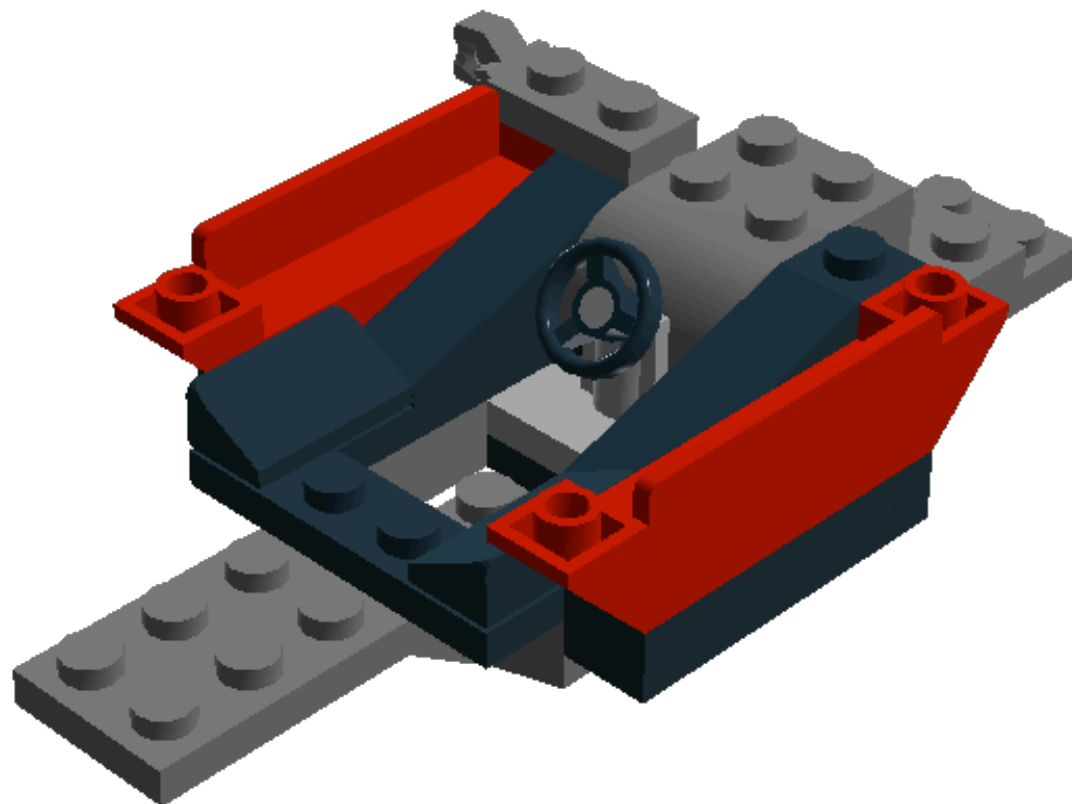

Step 7 of 45

1 x



1 x



1 x



1 x

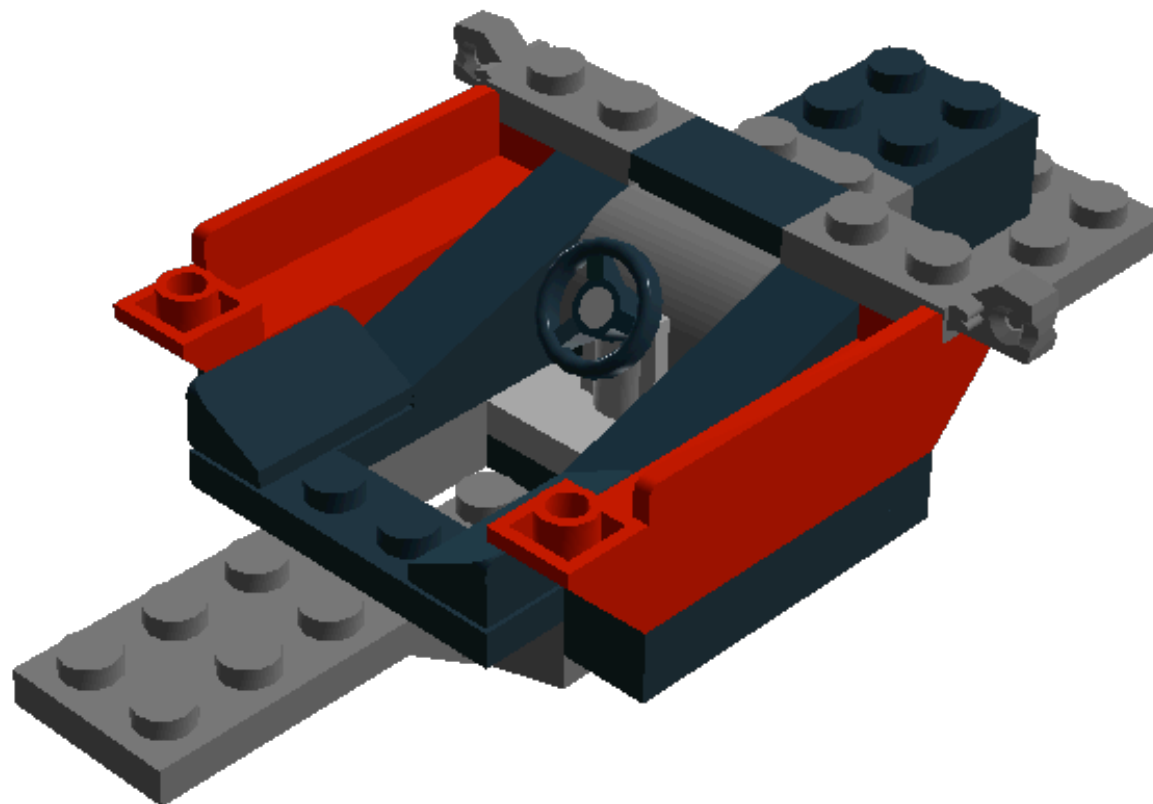



Step 8 of 45

1 x

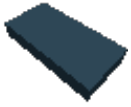

1 x



1 x

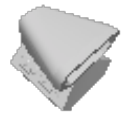

1 x

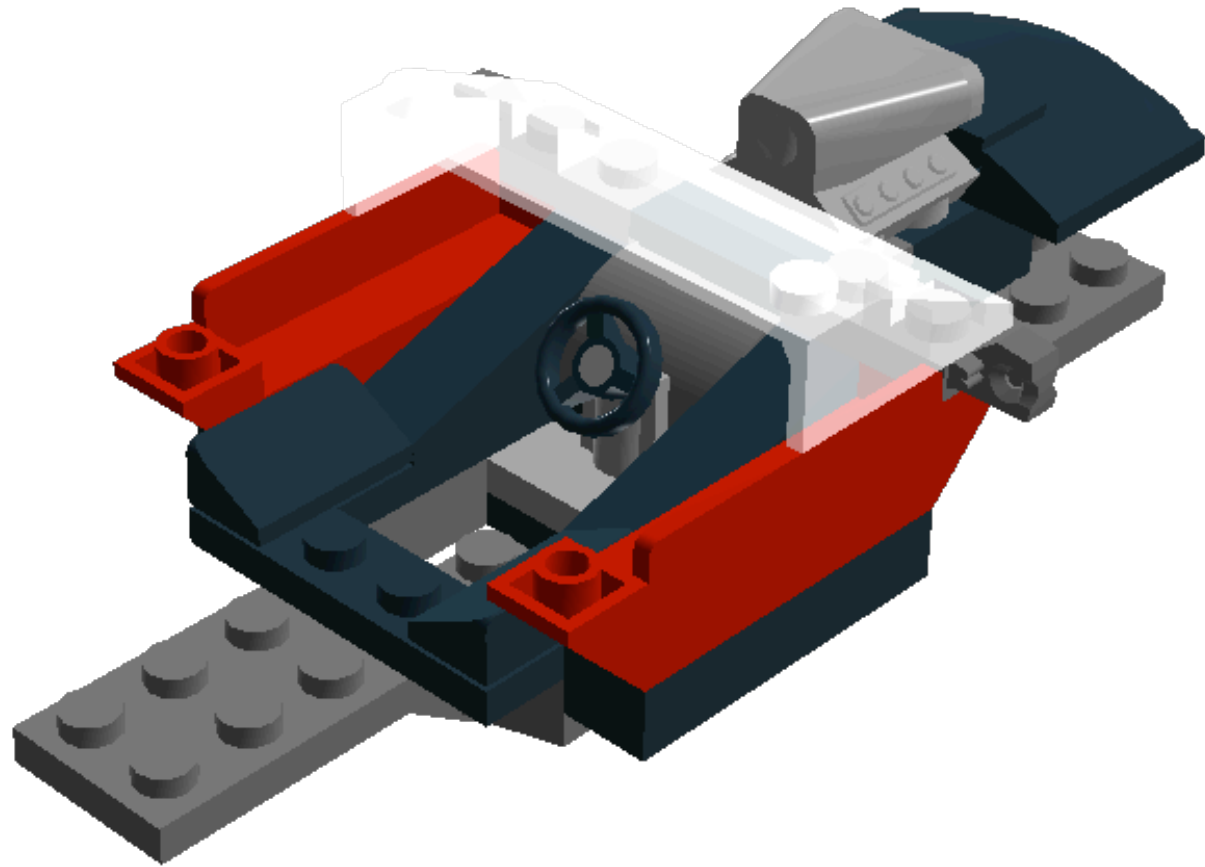

Step 9 of 45

1 x



1 x



1 x



1 x

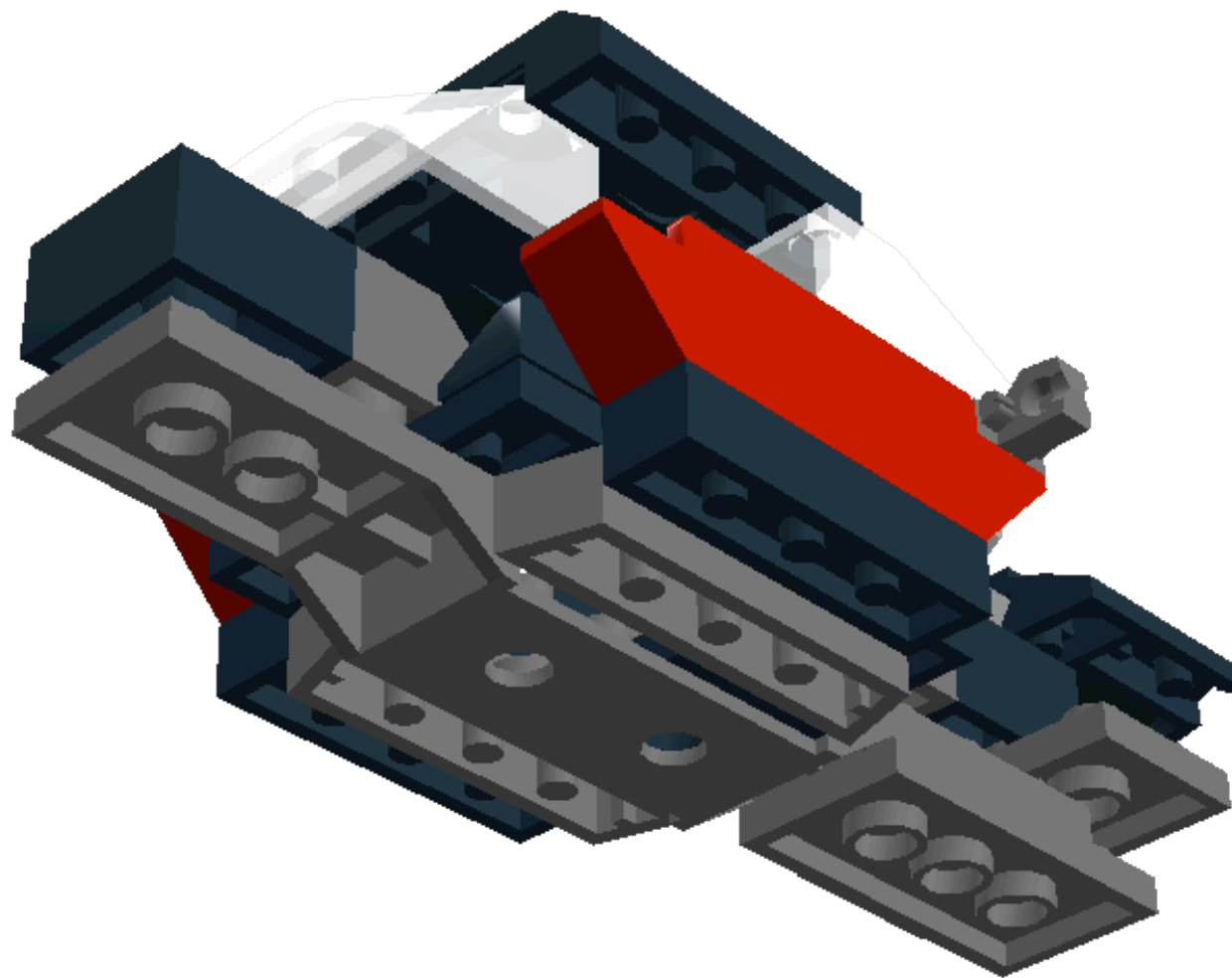
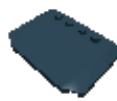

Step 10 of 45

1 x



1 x



2 x

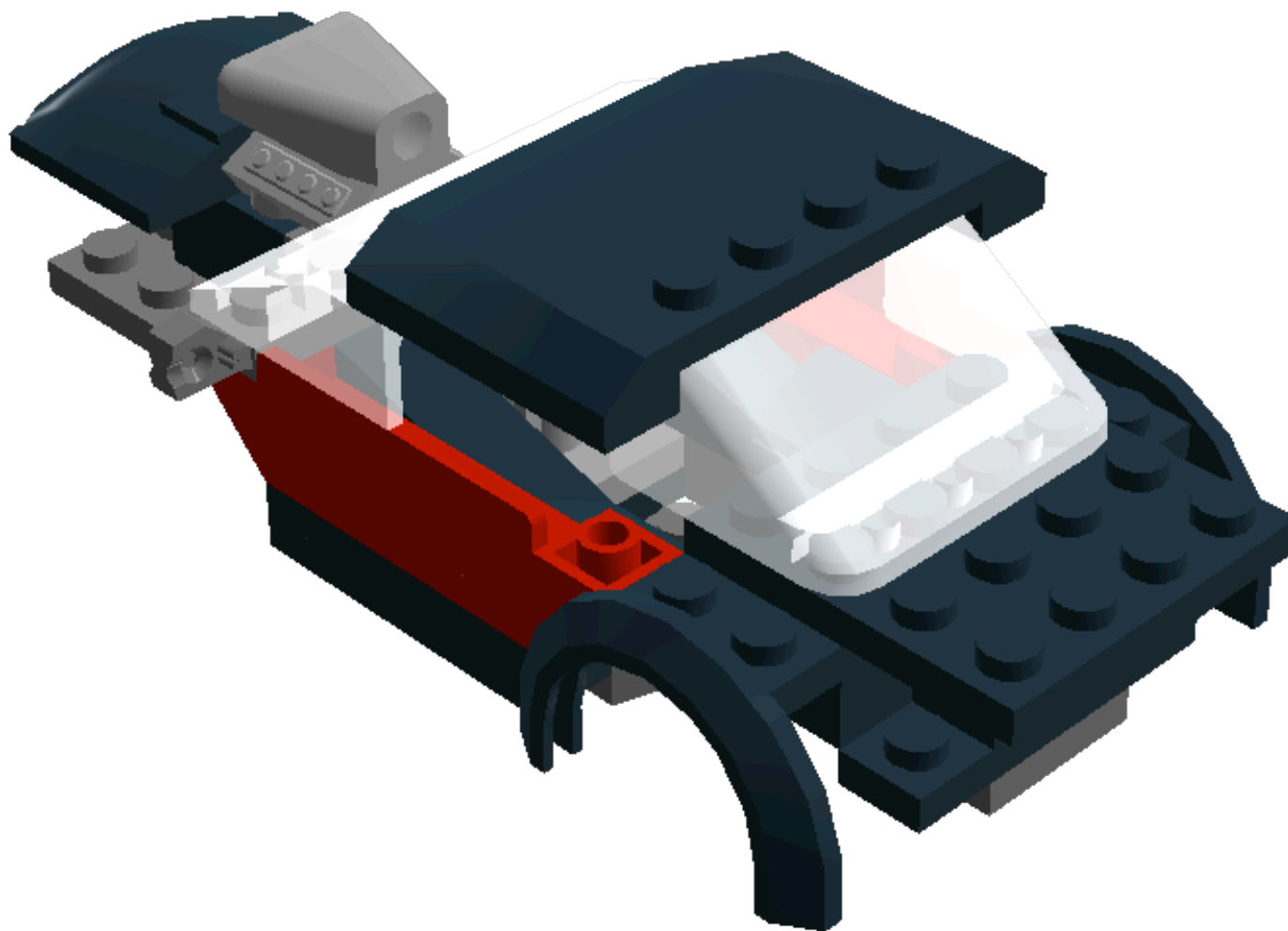

Step 11 of 45

1 x



1 x

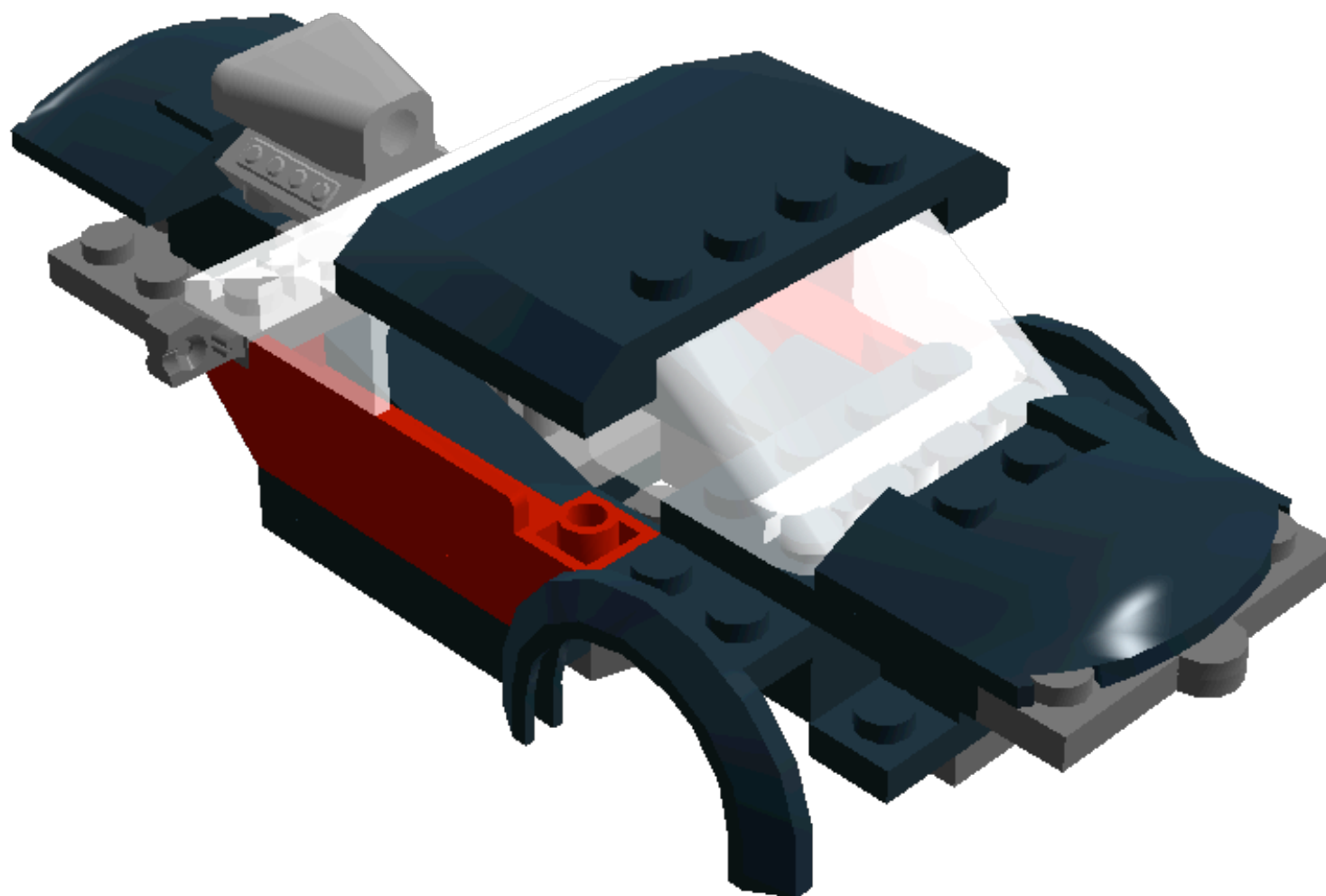

Step 12 of 45

1 x



1 x



1 x





Step 14 of 45

1 x



1 x



1 x



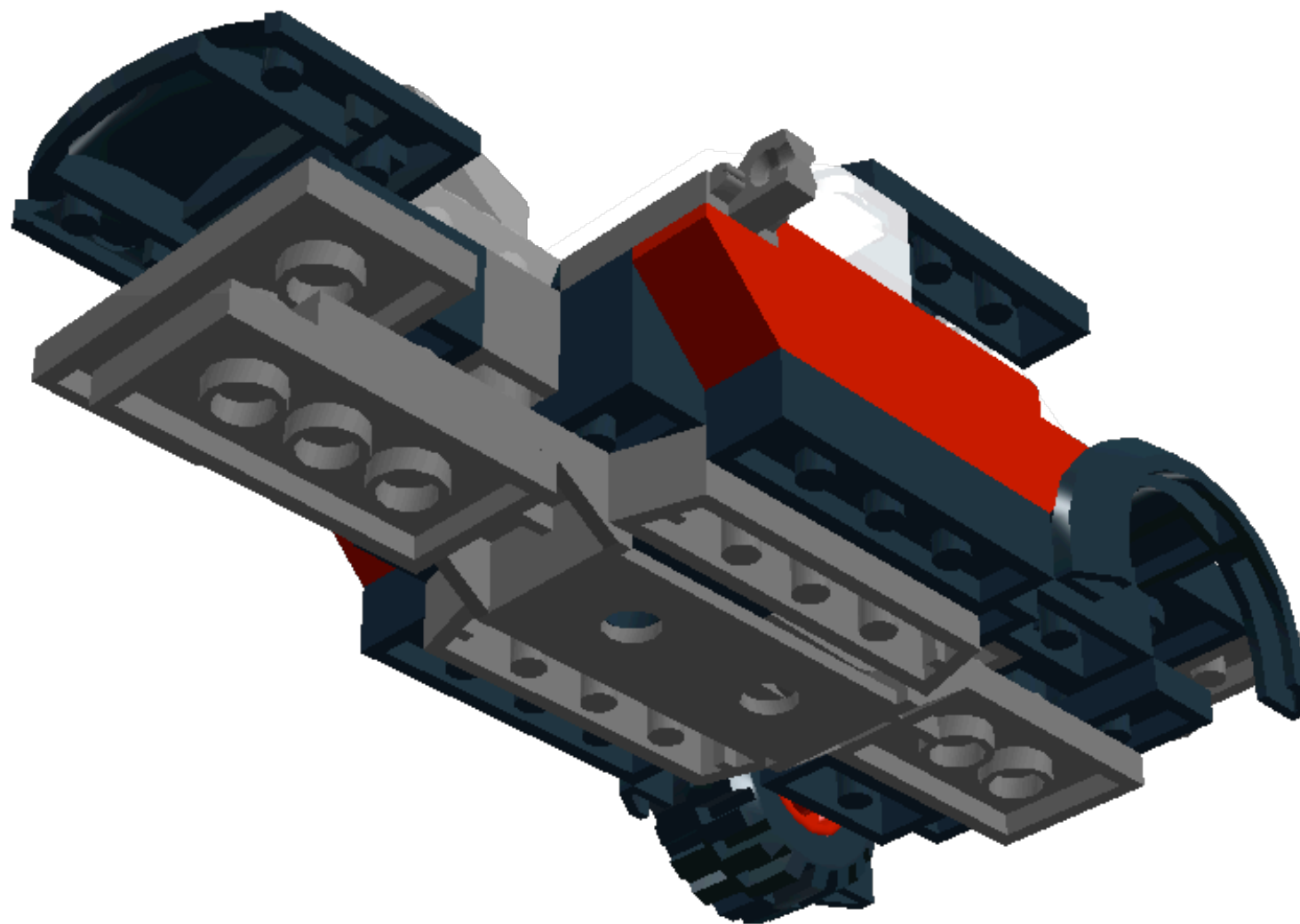



Step 16 of 45

1 x



Step 17 of 45

1 x



1 x



1 x



1 x

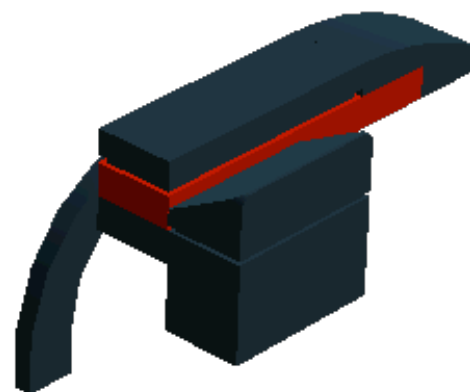

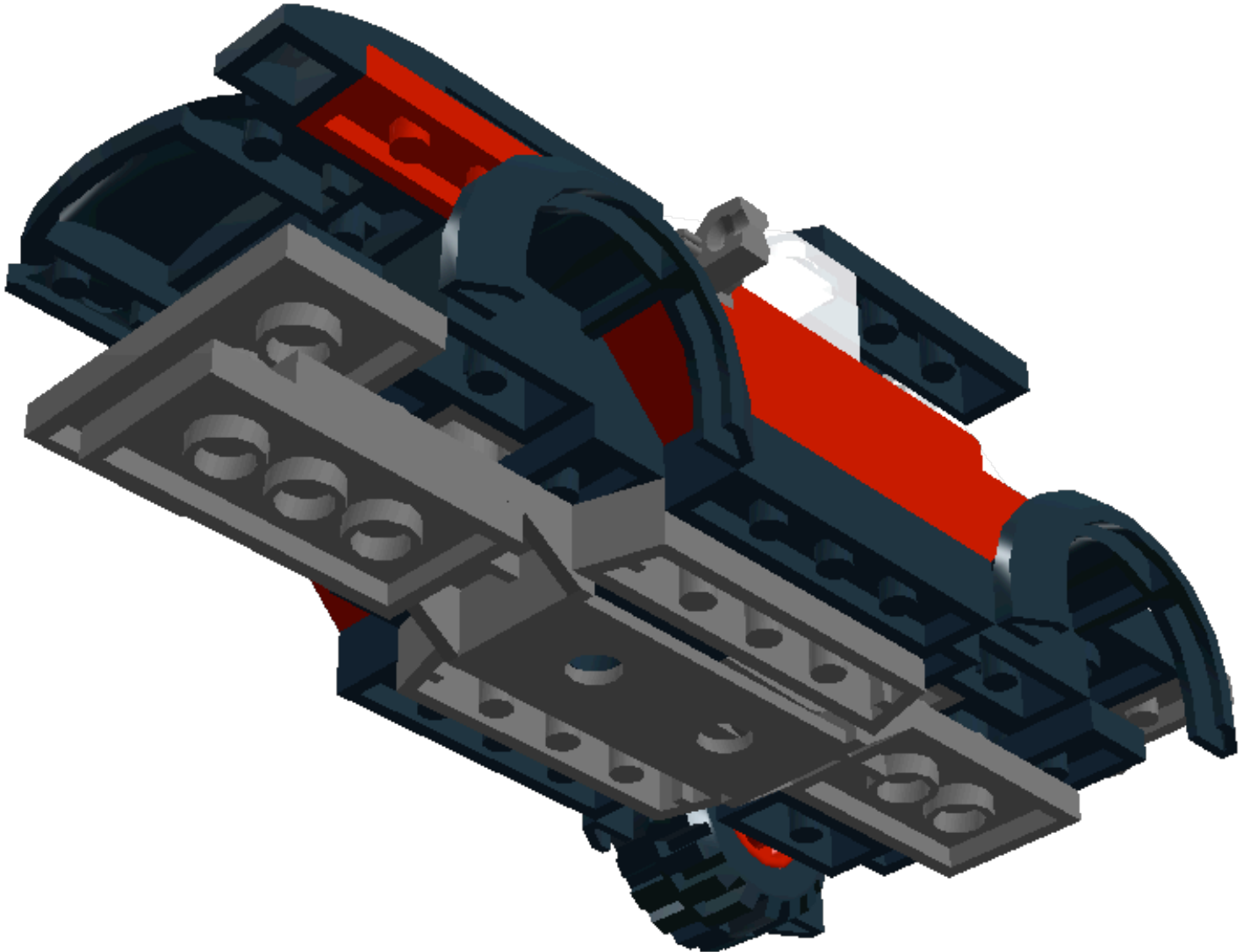

Step 19 of 45

1 x



1 x



1 x



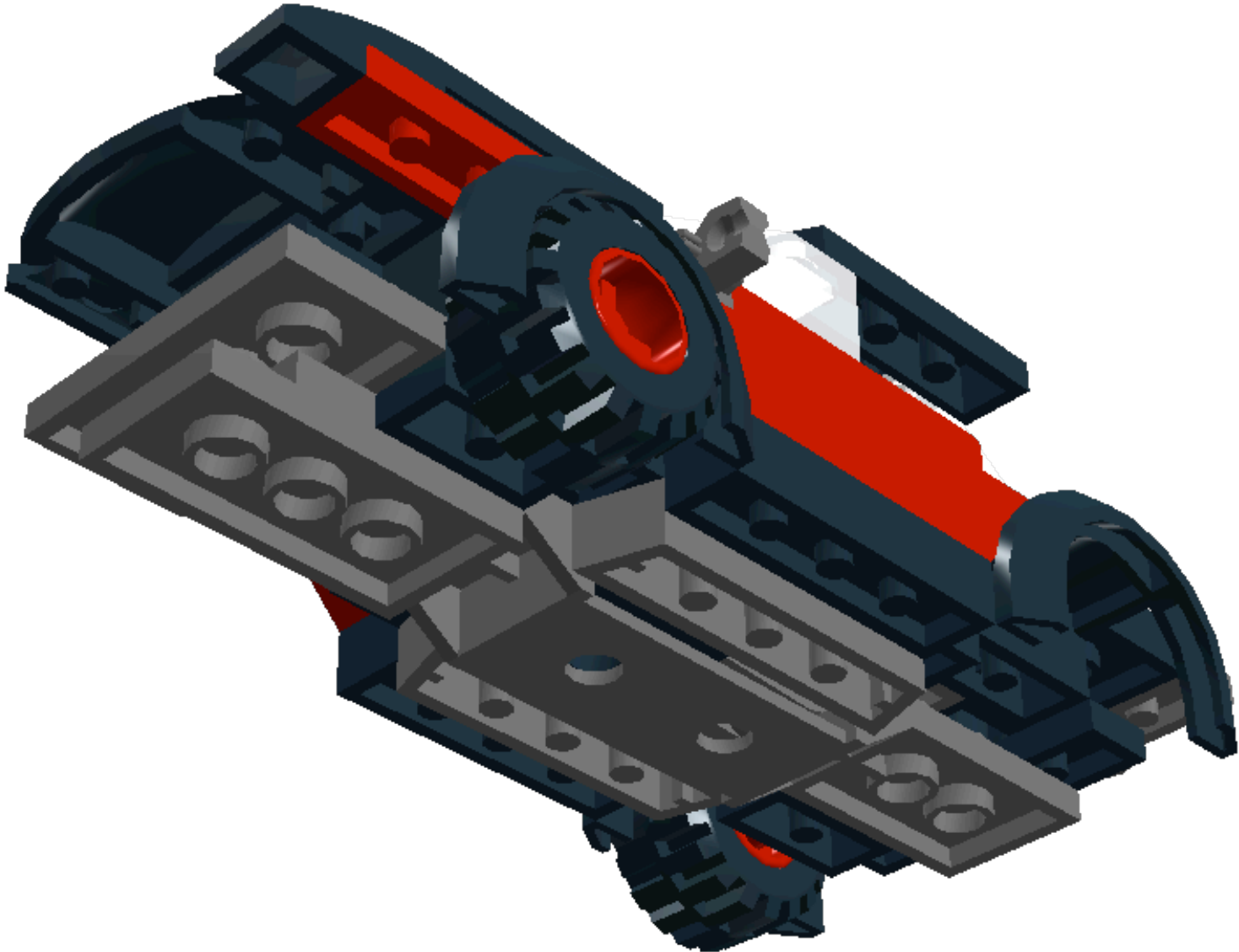

Step 21 of 45

1 x



Step 22 of 45

1 x



1 x



1 x



1 x



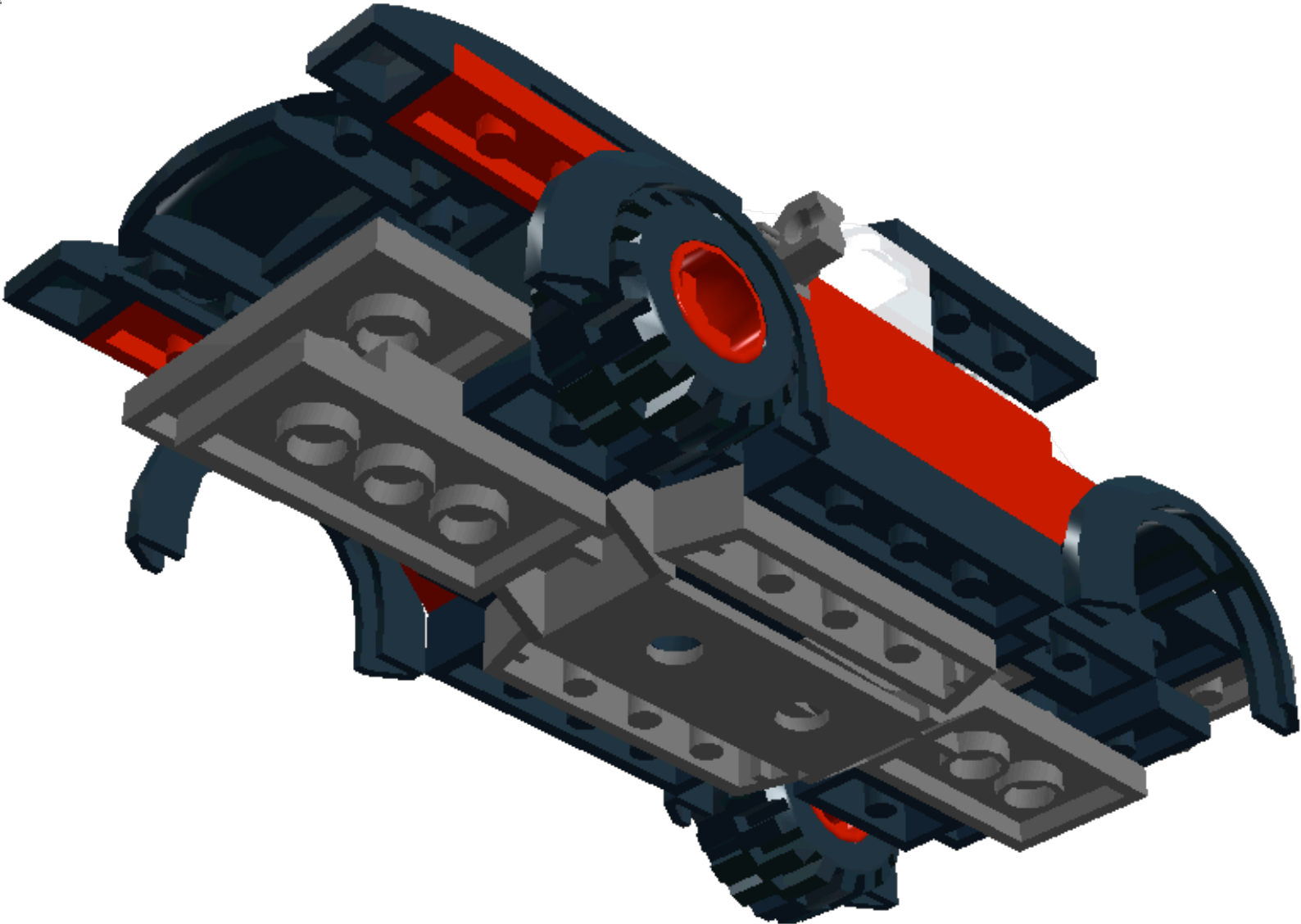



Step 24 of 45

1 x



1 x



1 x

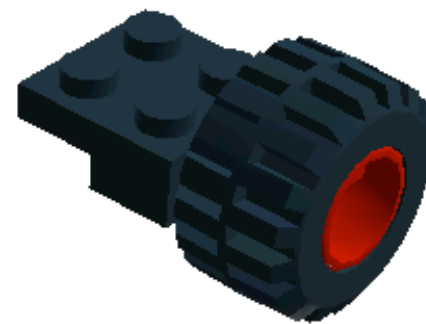

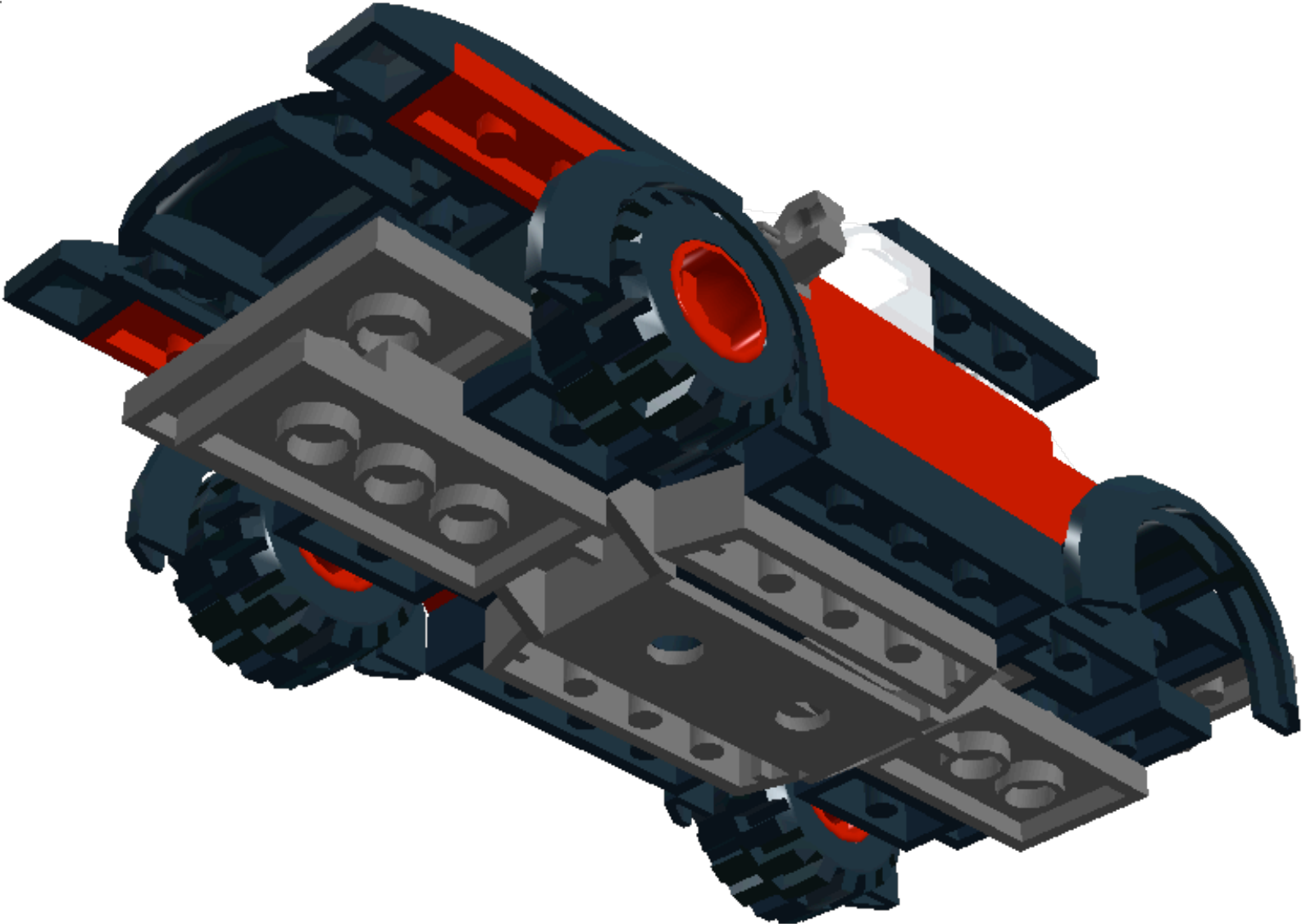

Step 26 of 45

1 x



1 x



1 x



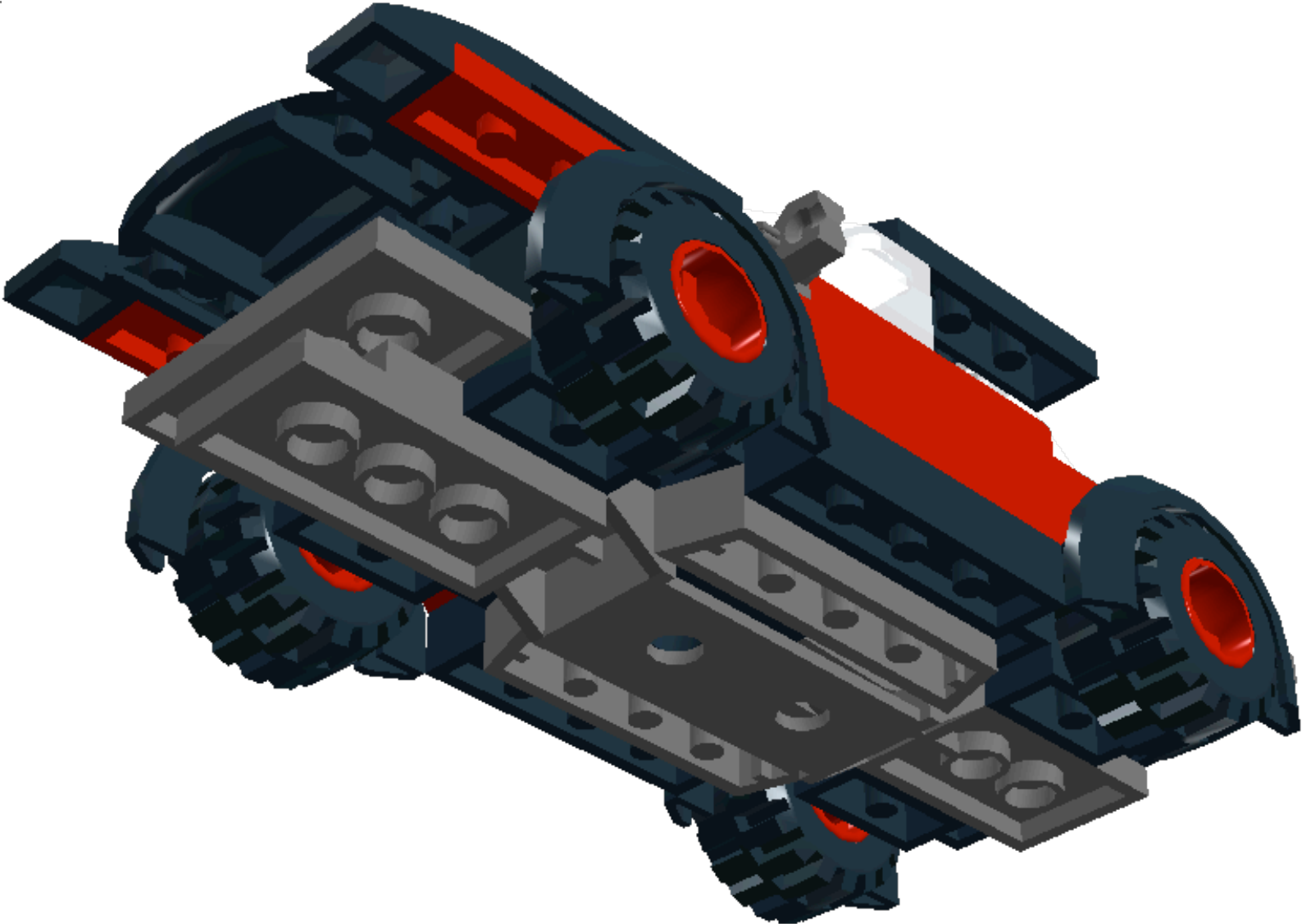

Step 28 of 45

1 x



1 x



2 x

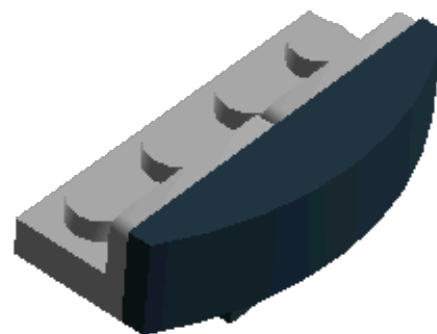

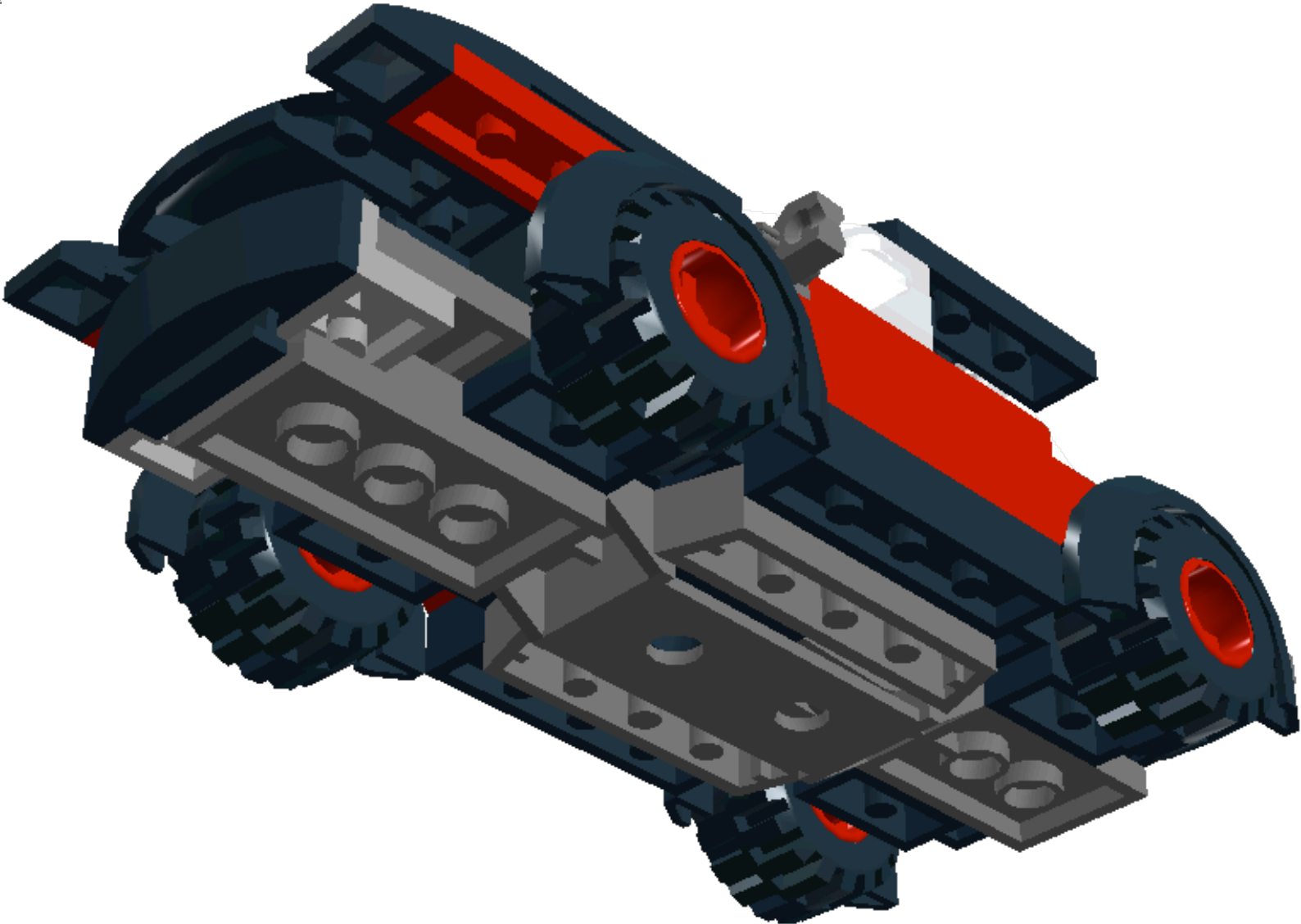

Step 30 of 45

1 x

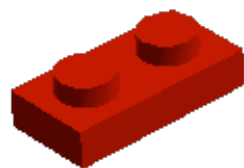

Step 31 of 45

1 x



1 x



1 x



1 x

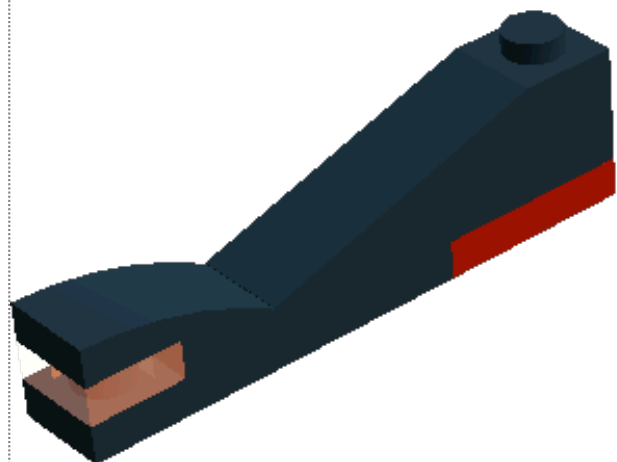



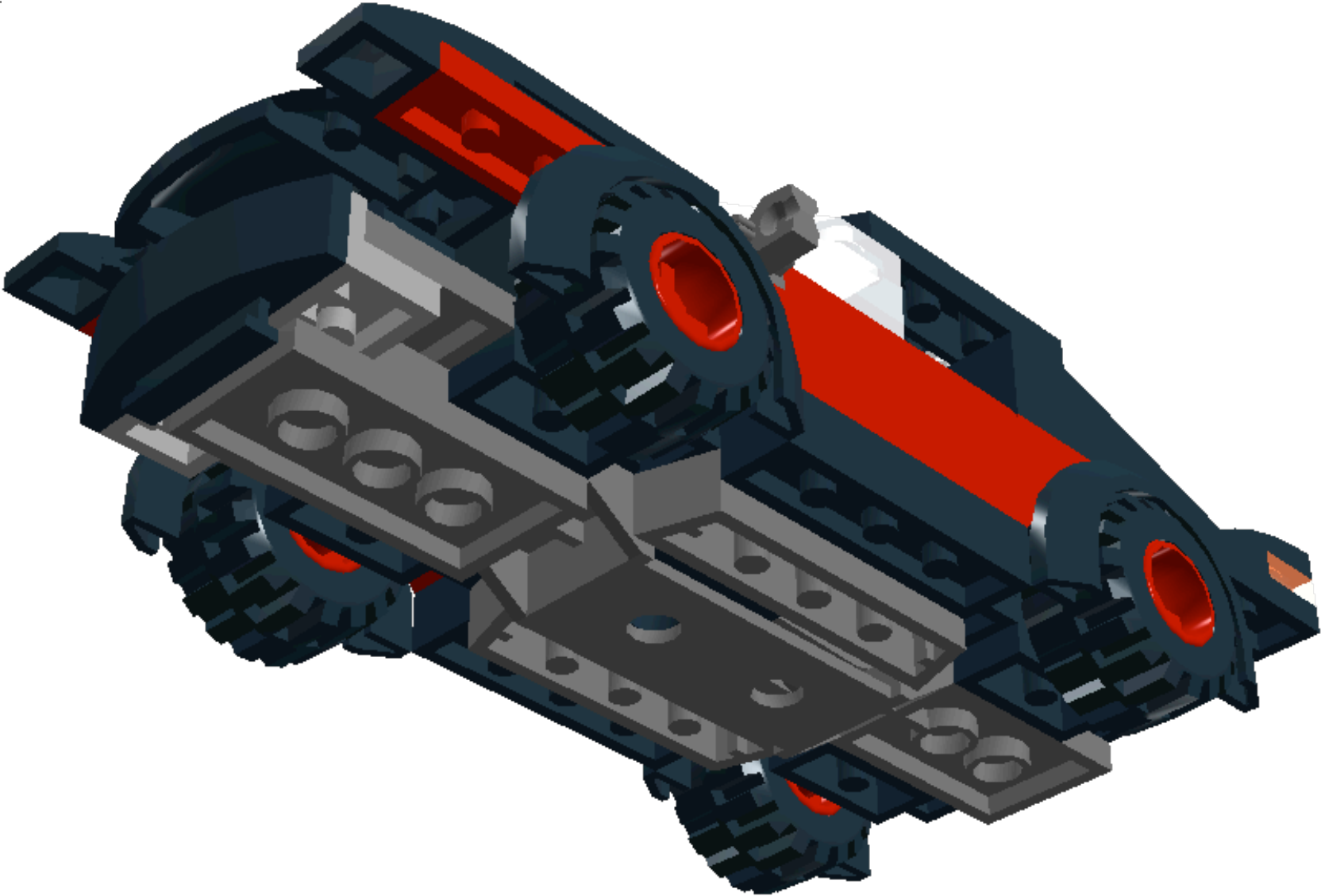

Step 33 of 45

1 x

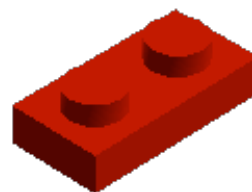



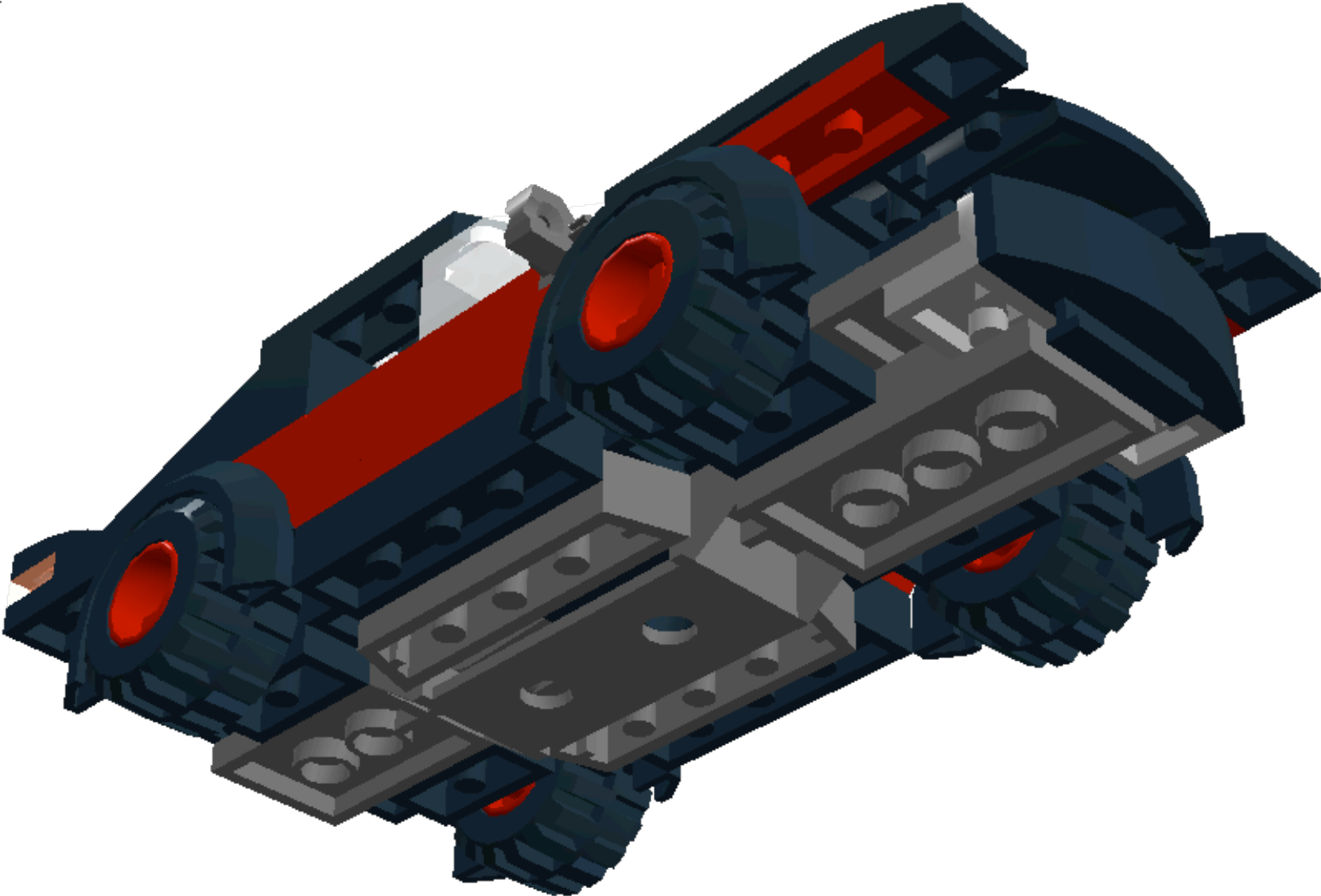

Step 36 of 45

1 x

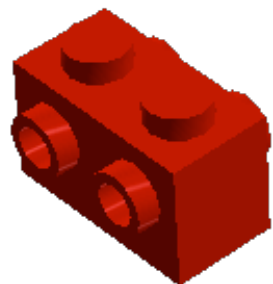

Step 37 of 45

1 x



1 x



1 x



1 x



Step 38 of 45

1 x



1 x



2 x

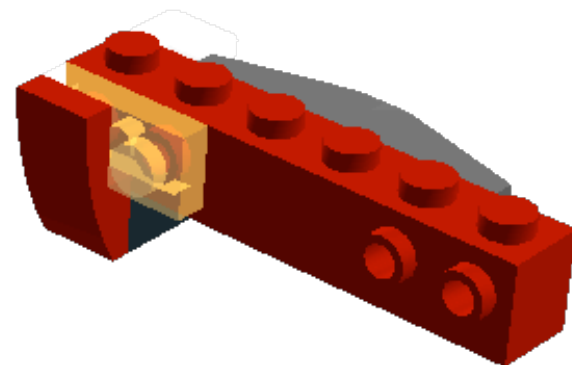

Step 39 of 45

1 x



1 x



1 x



1 x

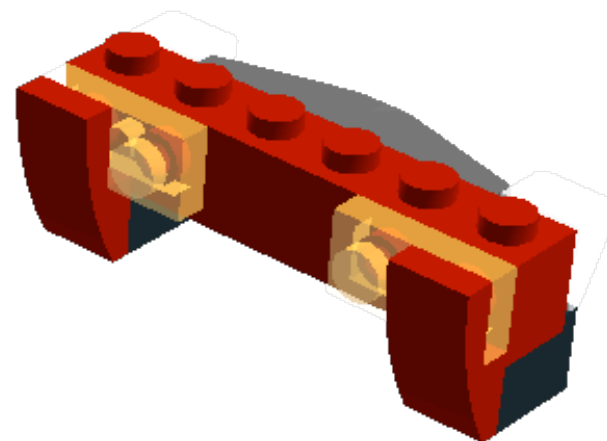



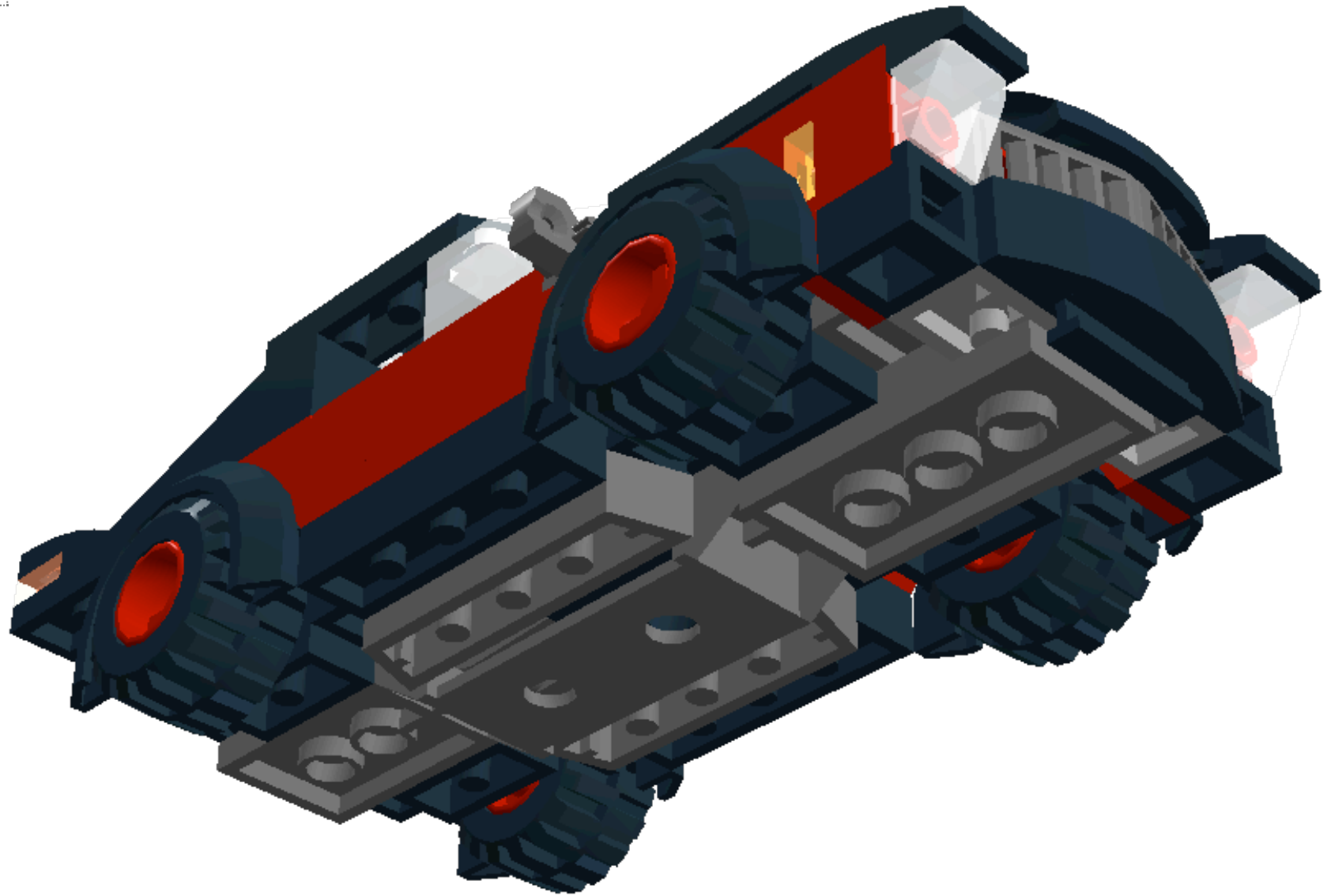

Step 41 of 45

1 x



1 x



1 x



1 x

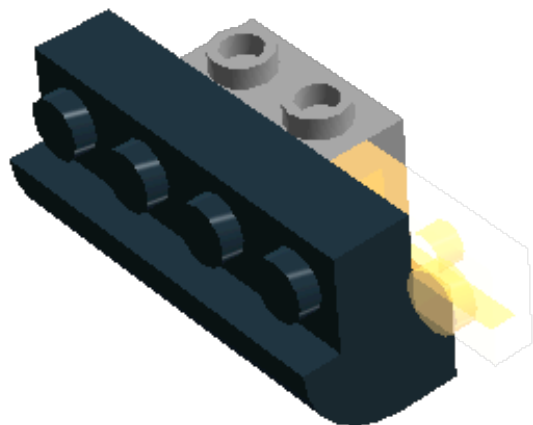

Step 42 of 45

1 x



1 x



1 x



1 x

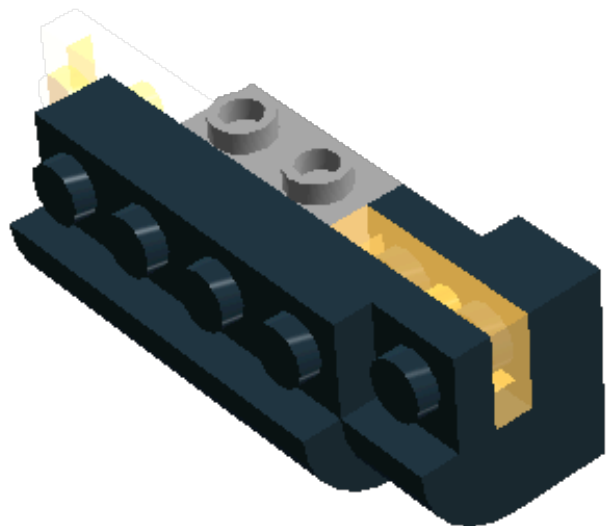

Step 43 of 45

1 x



1 x



1 x



1 x

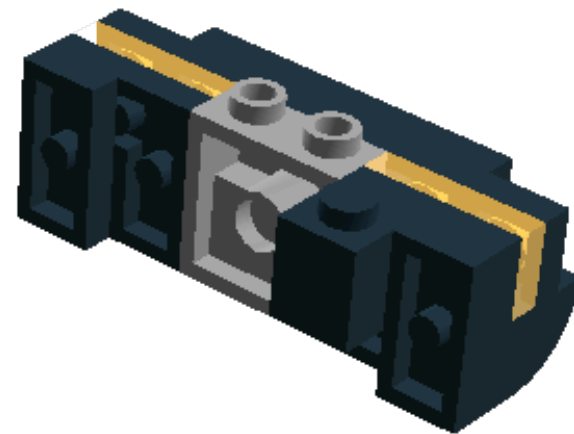

Step 44 of 45

1 x

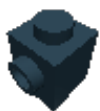

2 x



1 x

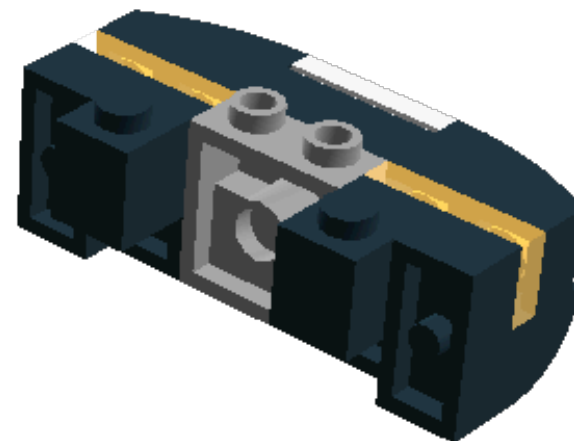

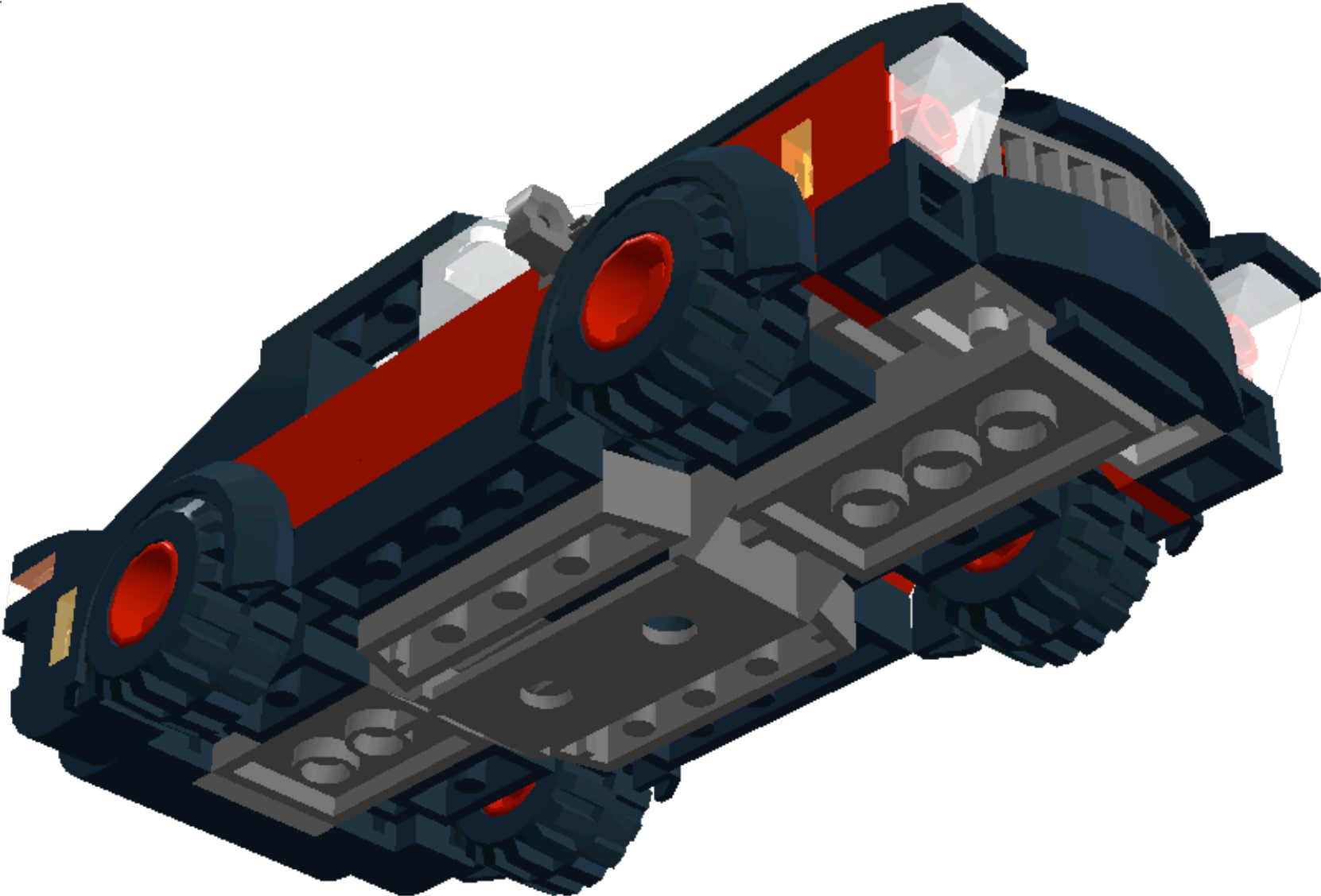



2 x  BRICK 2X2 - Black

2 x  ANGULAR BRICK 1X1 - Black

2 x  BRICK 1X1 W. 1 KNOB - Black

1 x  BRICK 1X2 W. 2 KNOBS - Bright Red

2 x  BRICK 1X2 W. FOUR KNOBS - Bright Red

2 x  ROOF TILE 1X1X2/3, PC - Transparent

4 x  ROOF TILE 1 X 2 X 2/3, ABS - Black

1 x  ROOF TILE 2X2/45° - Dark Stone Grey

4 x  ROOF TILE 1X4X1 - Black

2 x  INVERTED ROOF TILE 6X1X1 - Bright Red

2 x  PLATE W. BOW 1X2X2/3 - Bright Red

6 x  PLATE W. BOW 1X2X2/3 - Black

2 x  BRICK W. ARCH 1X1X1 1/3 - Black

1 x  PLATE W. BOW 1X4X2/3 - Black

1 x  BRICK 2X3 W. ARCH - Dark Stone Grey

1 x  BRICK W. BOW 4X1X1 1/3 - Black

2 x  PLATE 1X1 - Tr. Red

1 x  FLAT TILE 1X2 - White

2 x  FLAT TILE 1X2 - Black

2 x  PLATE 1X2 - Bright Red

3 x  PLATE 1X2 - Black

4 x  PLATE 1X2 - Tr. Bright Orange

2 x  FLAT TILE 1X3 - Black

4 x  CORNER PLATE 1X2X2 - Black

1 x  PLATE 2X2 - Black

2 x  PLATE 1X4 - Bright Red

7 x  PLATE 1X4 - Black

2 x  PLATE 2X4 - Black

2 x  PLATE 2X4 - Dark Stone Grey

1 x  PLATE 4X4 - Black

1 x  PLATE 1X2 WITH SLIDE - Black

2 x  PLATE 1X2 W/STUB  
VERTICAL/END - Dark Stone Grey

2 x  ANGULAR PLATE 1.5 BOT. 1X2 1/2  
- Medium Stone Grey

1 x  HINGE PLATE 1X2 - Dark Stone Grey

1 x  PLATE 2X2X2/3 W. 2. HOR. KNOB -  
Medium Stone Grey

1 x  WINDSCREEN 4X3X1 1/3 -  
Transparent





1 x  WINDSCREEN 3X6/25°, PC - Transparent

2 x  WALL ELEMENT 1X4X1 PC - Bright Red

4 x  RIM WIDE W. HOLE Ø11 - Bright Red

4 x  BEARING ELEMENT 2X2, SINGLE - Black

4 x  TYRE NORMAL WIDE Ø21 X 12 - Black

1 x  PLATE 4x12 W. BOTTOM 2X4X2/3 - Dark Stone Grey

2 x  ROOF TILE W. LATTICE 1x2x2/3 - Dark Stone Grey

1 x  CONSOLE W. WHEEL - Black, Medium Stone Grey

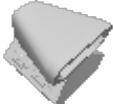
1 x  MOTOR 2X2X1 1/3 - Medium Stone Grey

2 x  PLATE W. BOW 3X4X2/3 W. KNOBS - Black

4 x  BRICK 2X4X1 W. SCREEN - Black

1 x  PLATE 4X6X2/3 - Black

1 x  MINI LOWER PART - Dark Stone Grey

1 x  MINI UPPER PART - Bright Yellow, Dark Stone Grey

1 x  MINI HEAD - Bright Yellow